

The background features a collage of industrial scenes. In the top left, there are blue electric motors. In the top right, a large metal shaft with a gear is shown. In the bottom left, a worker in a blue hard hat and safety vest is visible. In the center, a worker in a red safety jacket and blue hard hat is looking at a tablet. The entire image is overlaid with a white geometric grid pattern.

**FLUKE**<sup>®</sup>

Reliability

---

## **Adaptive Alignment: Solving Every Shaft Alignment Challenge**

---

Best Practices Webinar Series

# Meet the Speakers



## Keith Chuah

*Sales & Application Engineer, Fluke Reliability Solutions (PRUFTECHNIK)*

- 3 years of experience with PRUFTECHNIK
- 5 years of technical sales experience
- 11 years of experience in rotating equipment sector
- Bachelor of Engineering degree, Mechanical Engineering (Major Design & Innovation)



**Certified Laser Shaft  
Alignment  
(Mobius Institute)**



**Certified Vibration  
Analysis, ISO CAT I  
(Mobius Institute)**

# FLUKE®

Reliability

**db**® PRÜFTECHNIK

AZIMA | DLI

**emaint**™



World-class  
hardware



Remote condition  
monitoring services



Innovative  
Software



# Fluke Reliability: A Unique Proposition

- Under Fluke Reliability Solutions, we benefit from bringing leading brands Pruftechnik, eMaint, and Azima DLI together.

This creates a unique connected reliability ecosystem that enhances system, machinery, and team collaboration.

- The essence of a connected reliability ecosystem lies in its potential. We're paving the way for AI-enabled predictive functionalities, integrating data acquisition, and leveraging automated analytics.

This fusion of technology and innovation empowers maintenance teams, driving them to operate smarter, faster, and more effectively than ever before.



# Fluke Reliability: One mission, one shared purpose

“

We simplify connected reliability solutions for the people who keep the world up and running

”



# Install: Peak Performance from Day 1



Laser Shaft Alignment	Intrinsically Safe	Active Situational Intelligence	Geometrical Alignment	Pulley Alignment
			  	

# Connected Data

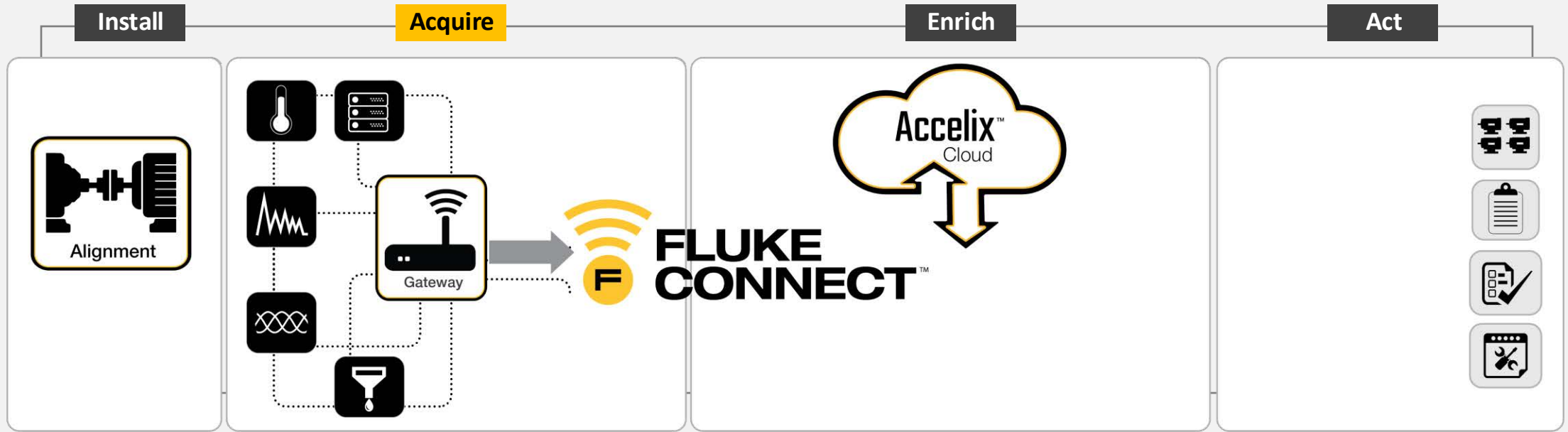

## Handheld Tools    Wired Sensors    Wireless Sensors    Automation & Controls



- Route- and sensor-based tools
- Simple to complex measurement
- Multiple P-F Curve modalities (vibration, ultrasound, oil analysis, etc.)

# Connected Systems

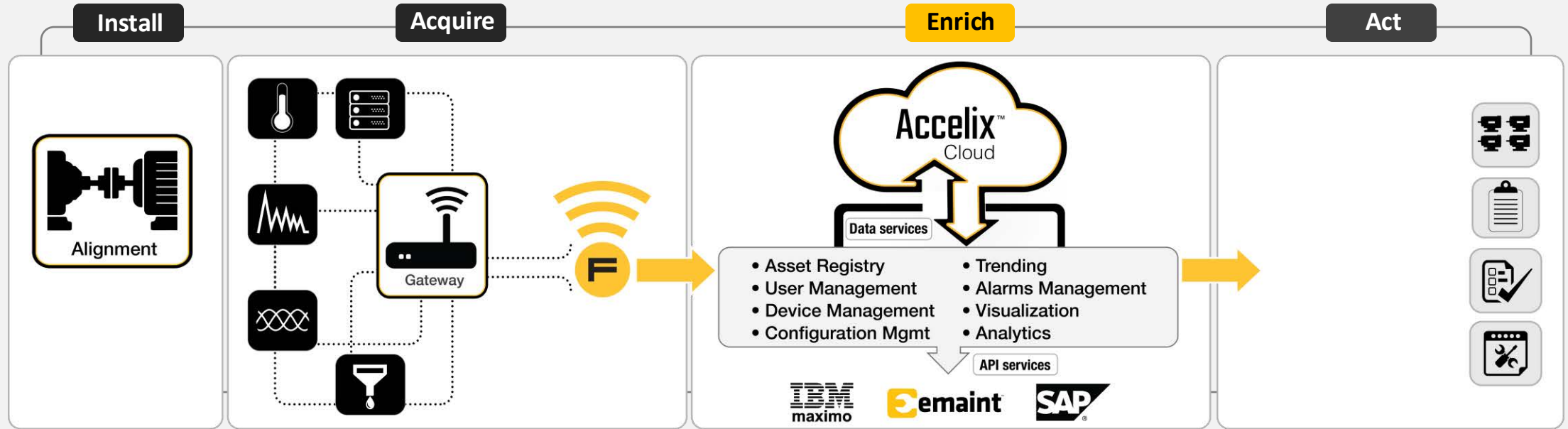

Data and API services provided by the Accelix Data Platform

Aggregated data supports long-term trend analysis and machine learning

Enriched condition data via integration with CMMS/EAM systems

## Result:

- A more complete picture of asset history and current health
- A solid basis for decision support and maintenance actions



# Connected Teams

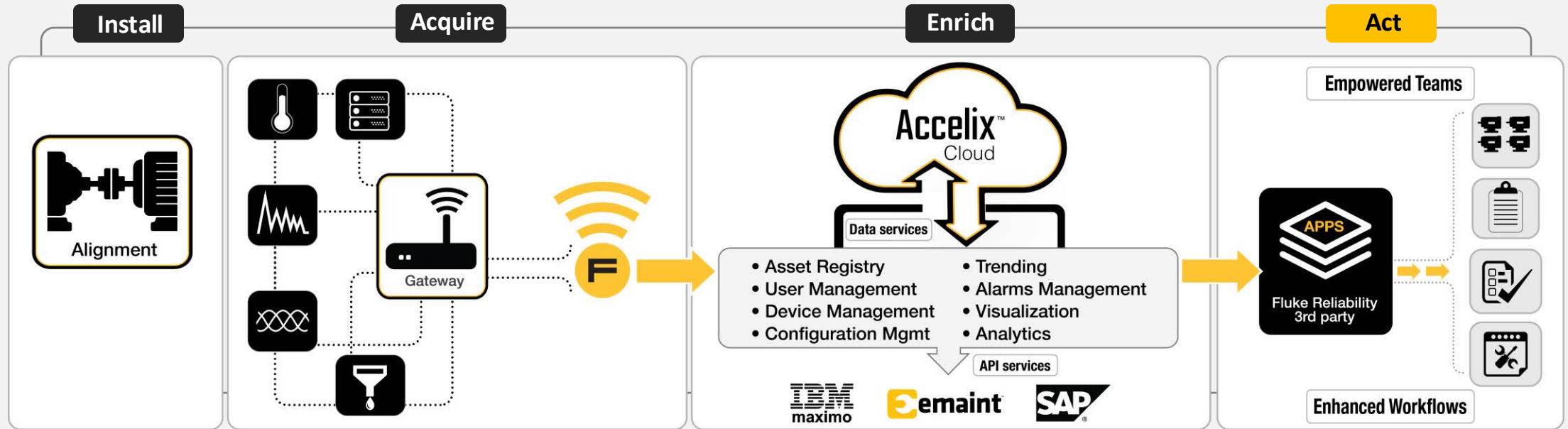

Reliability-centered maintenance actions | Mobile workforce enablement | Enhanced workflows

# Connected Knowledge

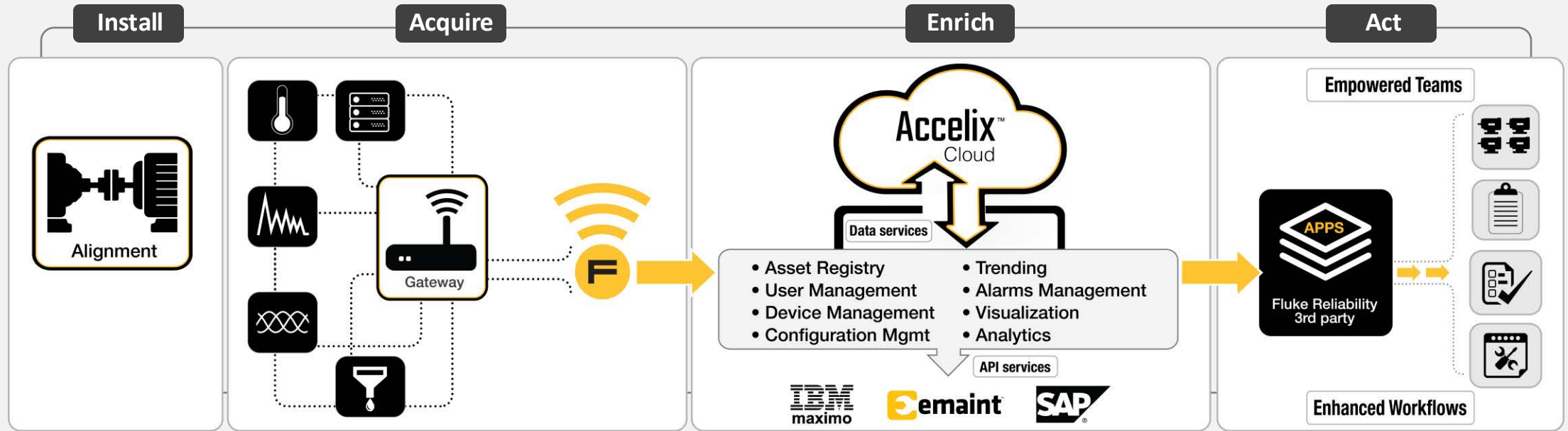

## Connected Knowledge Services



**Active Assistance**

- Onsite Machinery Services
- PARALIGN
- Onsite Vibration Diagnosis
- Remote Condition Monitoring



**On-Demand Expertise**

- ISO CAT Training
- Online & In-Person Courses
- Reliability Program Consulting
- Customer Success Team

# What is Shaft Alignment?

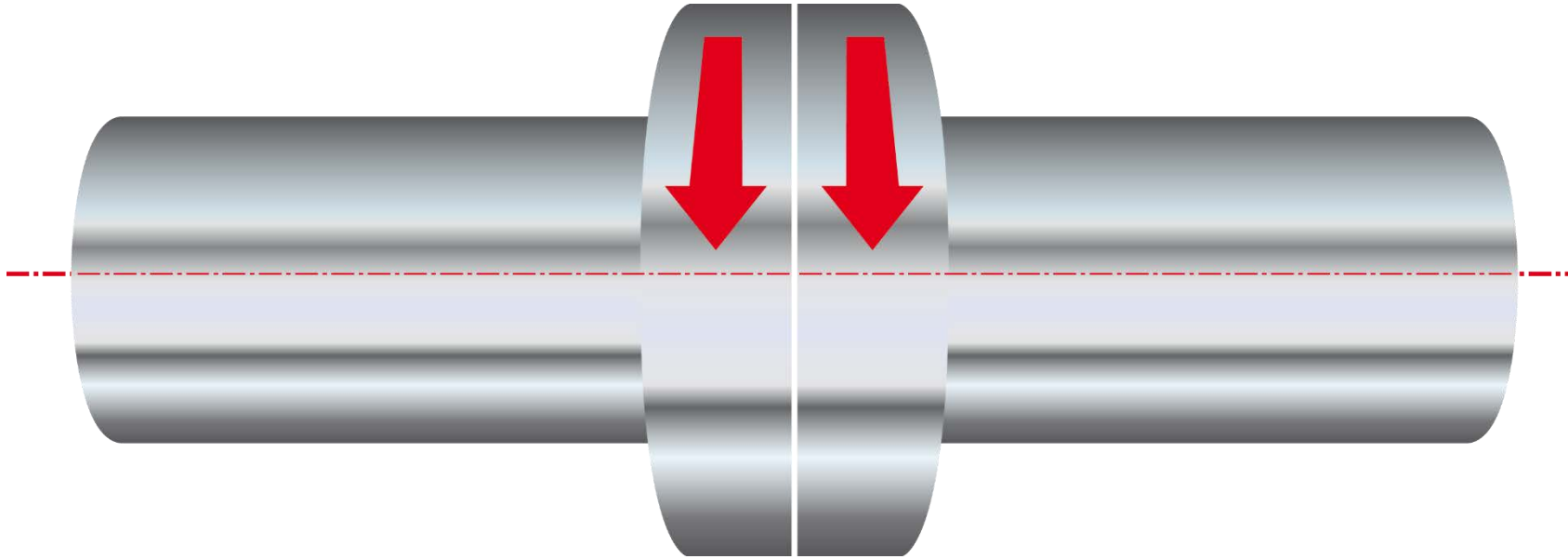

... at the **point of power transfer** from one shaft to another, the **axes of rotation** of both shafts should be colinear at **certain tolerance** when the machine is running under **normal operating conditions** ...

# Case study: Are your machine's alignment within tolerance?

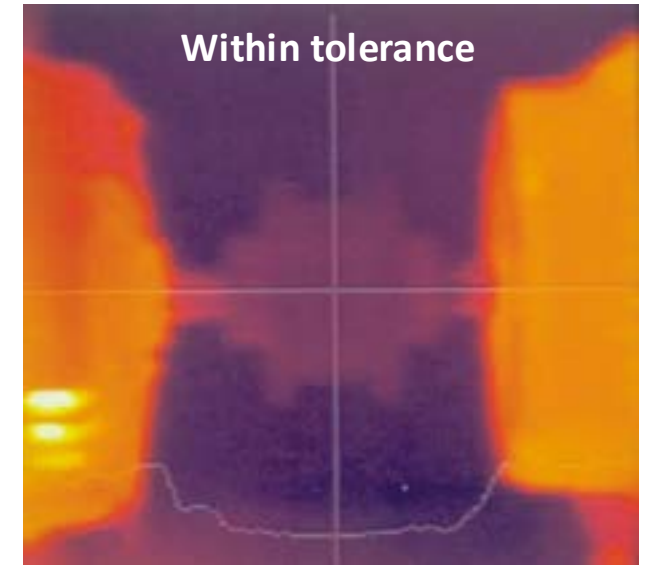
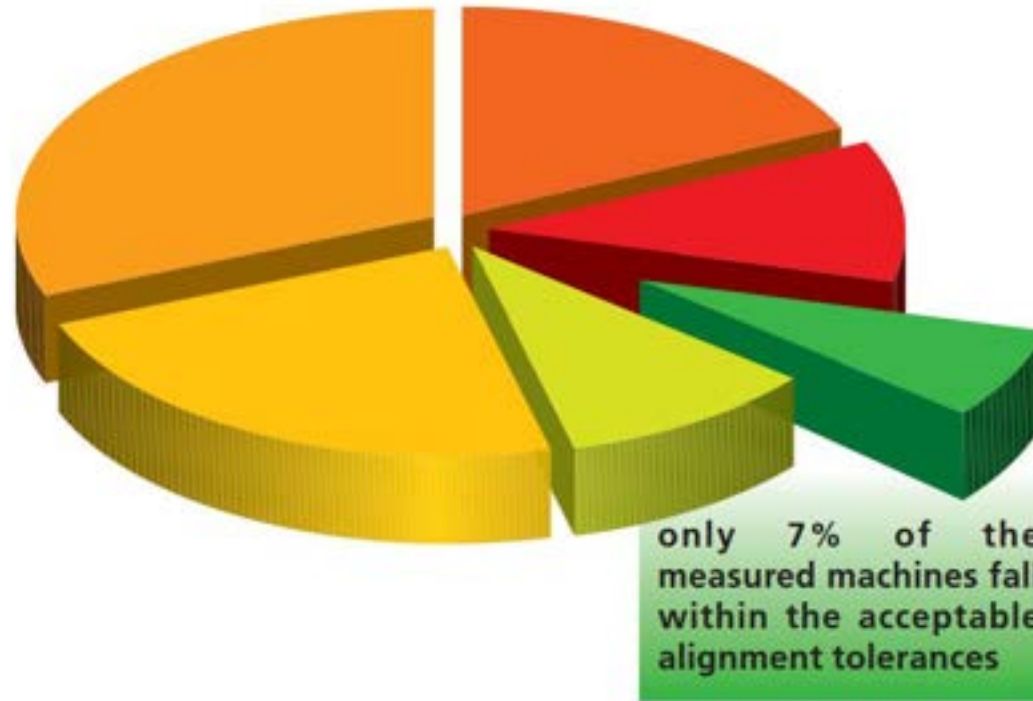
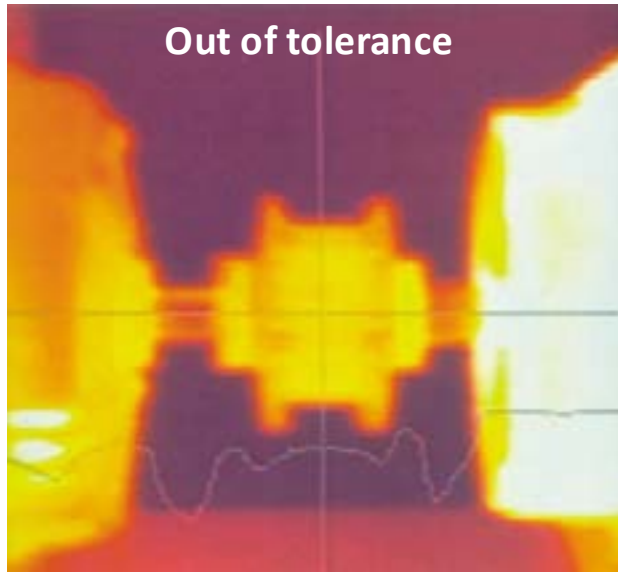

Statistics courtesy of a major UK chemical company



# Benefits of precision laser alignment

Variation of power consumption

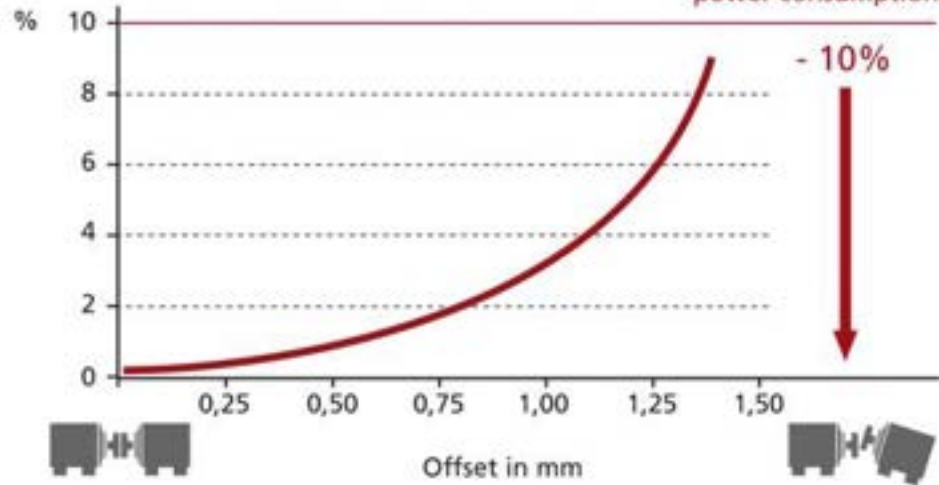

Bearing life cycle (%)

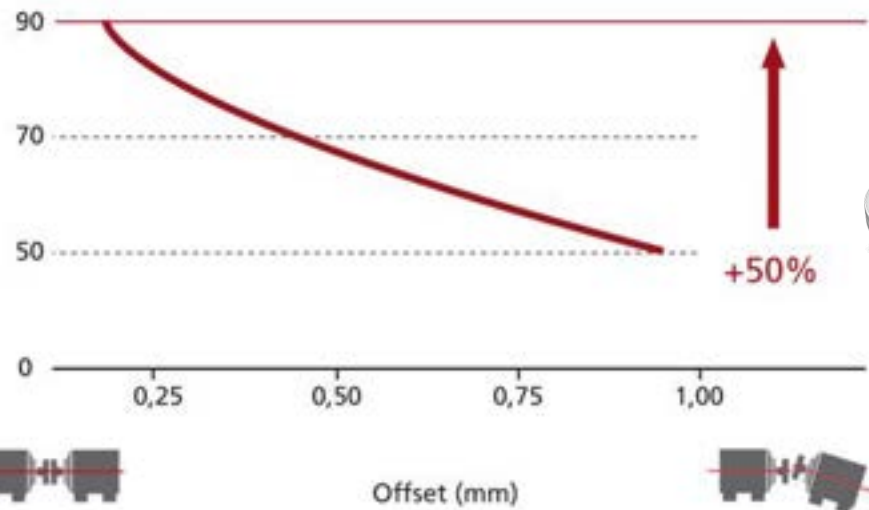

Number of mechanical seal repairs

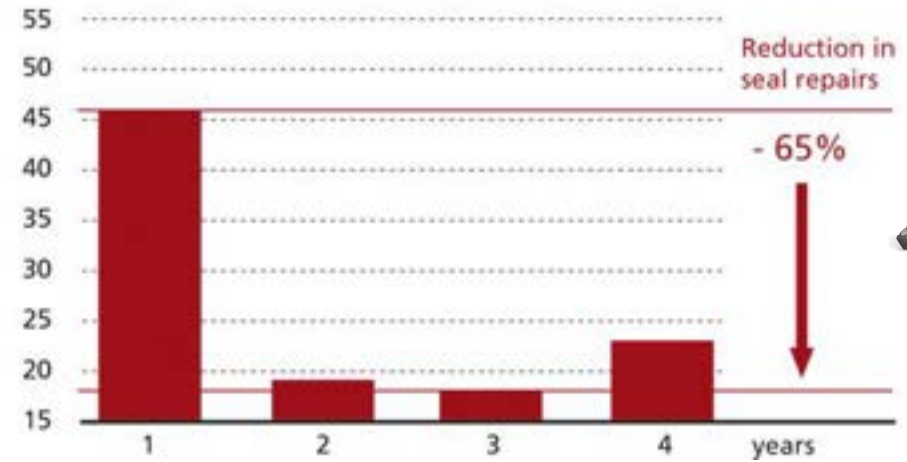

Number of pump repairs

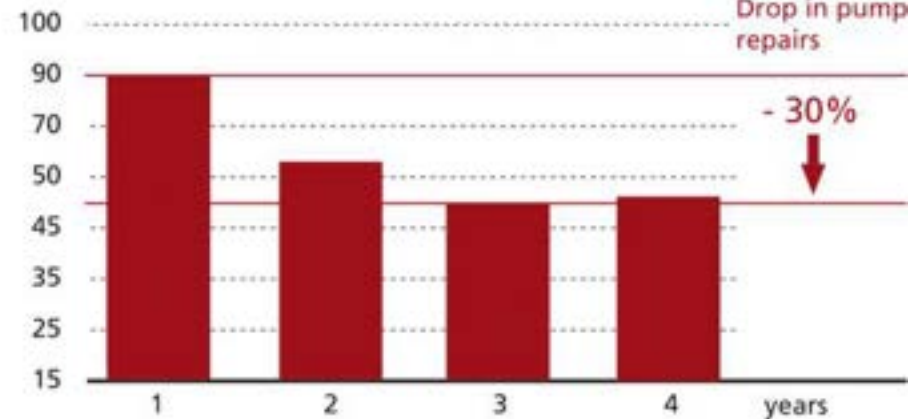

## Short history: Alignment of machines → Ruler and feeler gauge

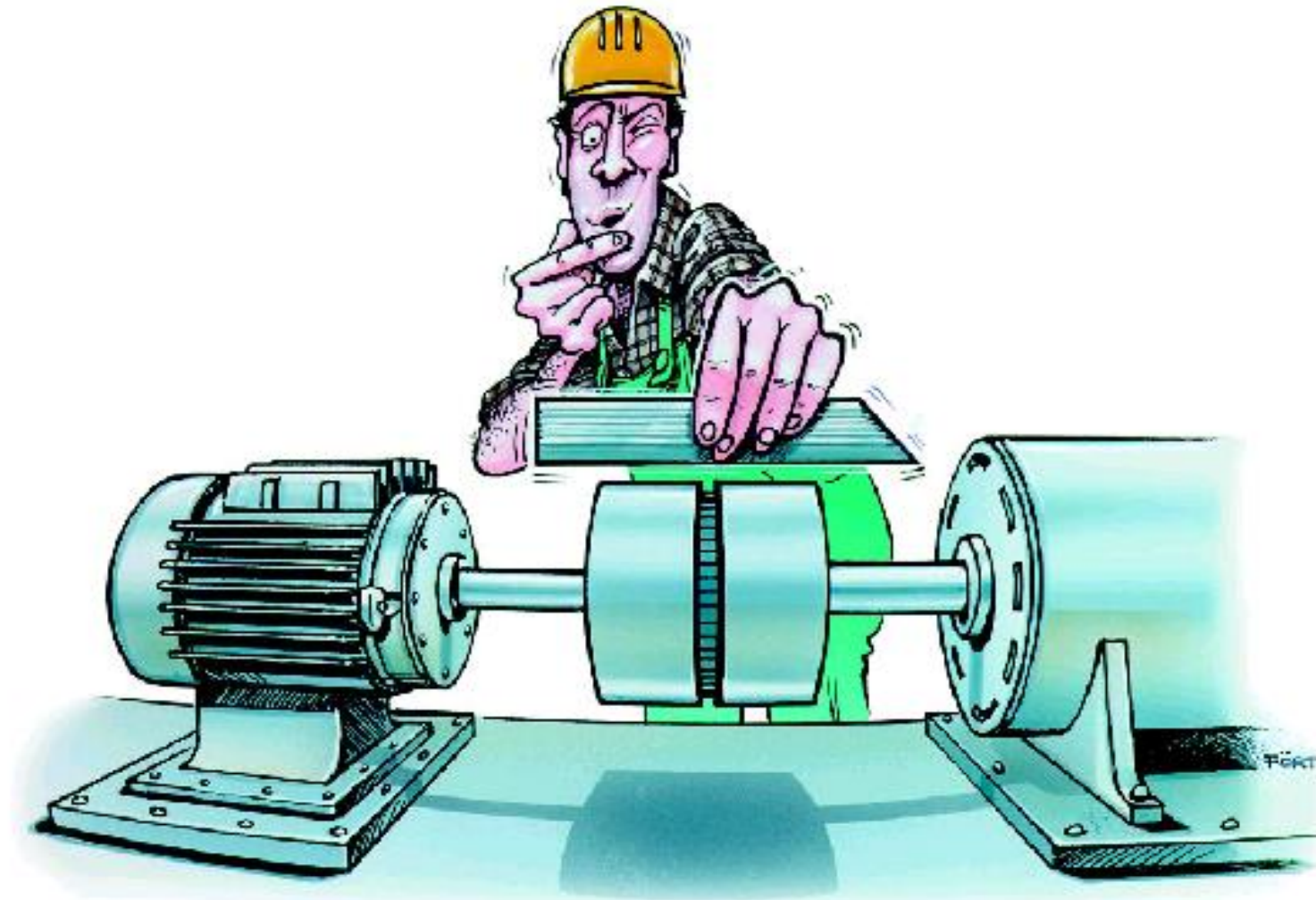

# Short history: Alignment of machines → dial gauges

## Rim and Face method

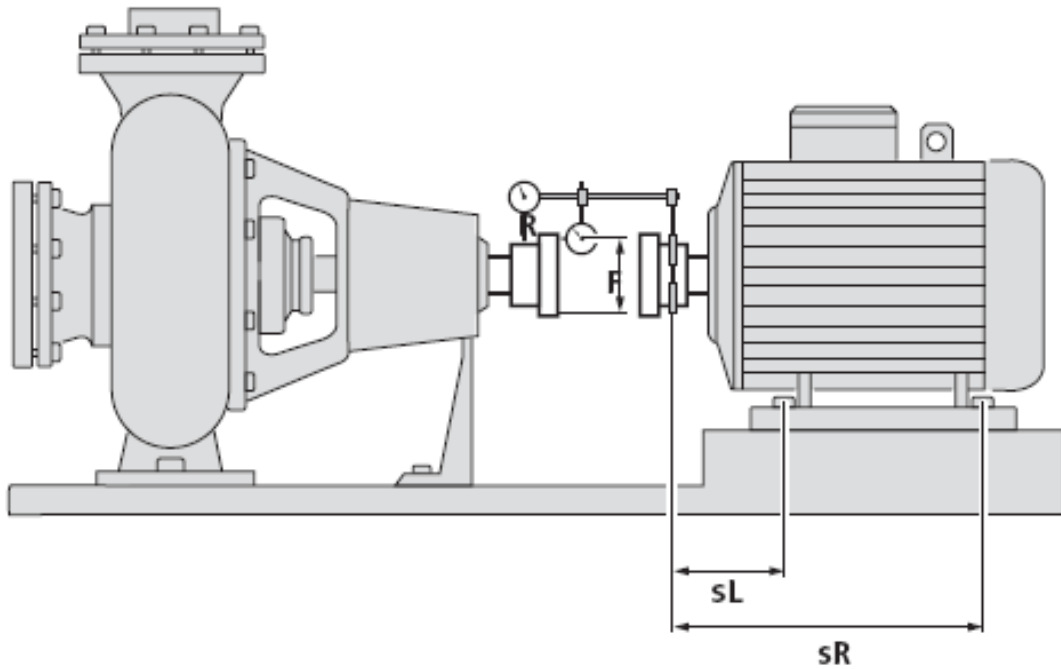

## Reverse indicator method

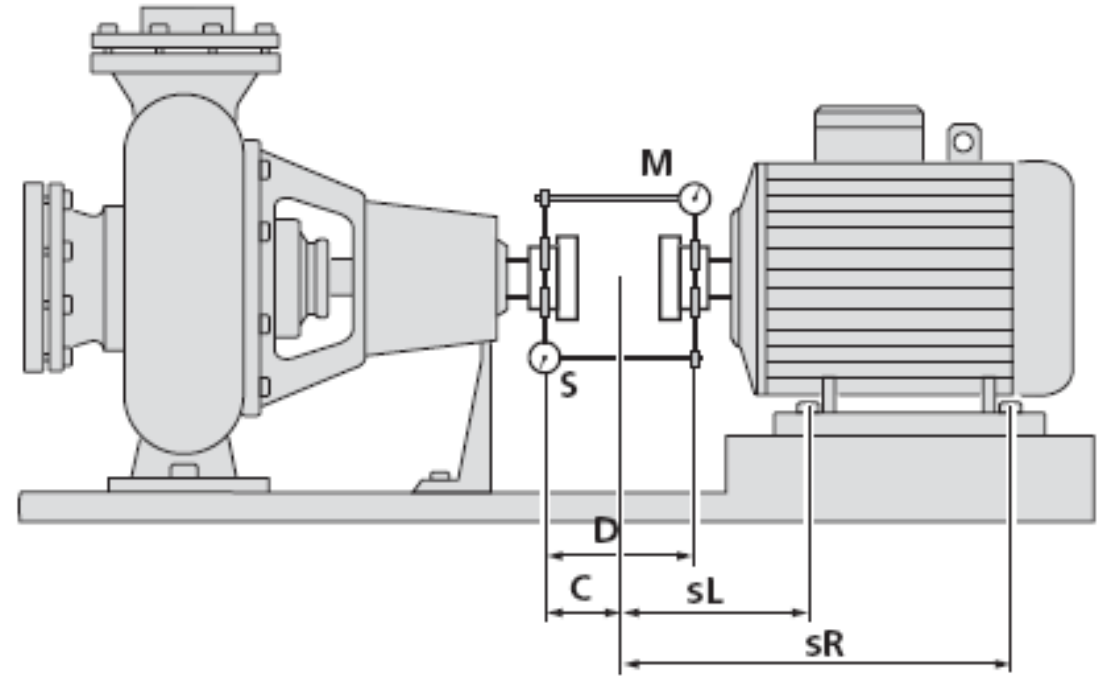

# Short history: Alignment of machines → 1982 - PRUFTECHNIK ALI2000

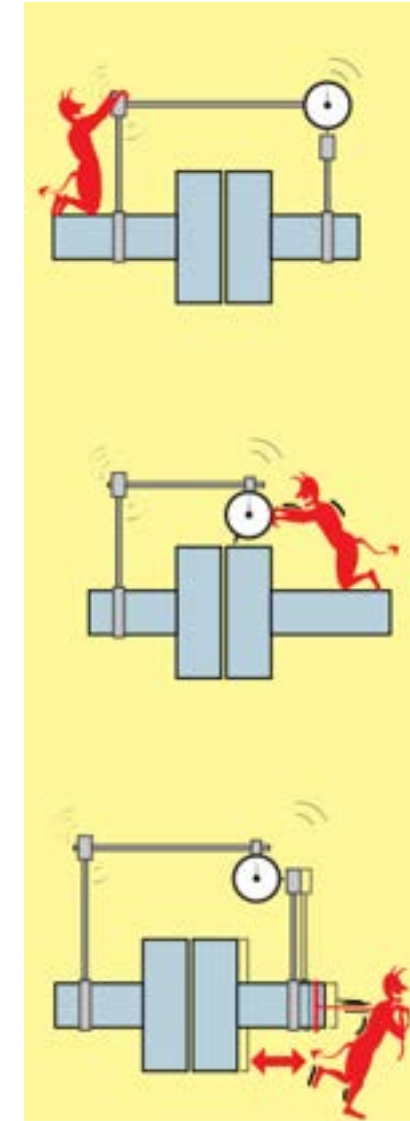
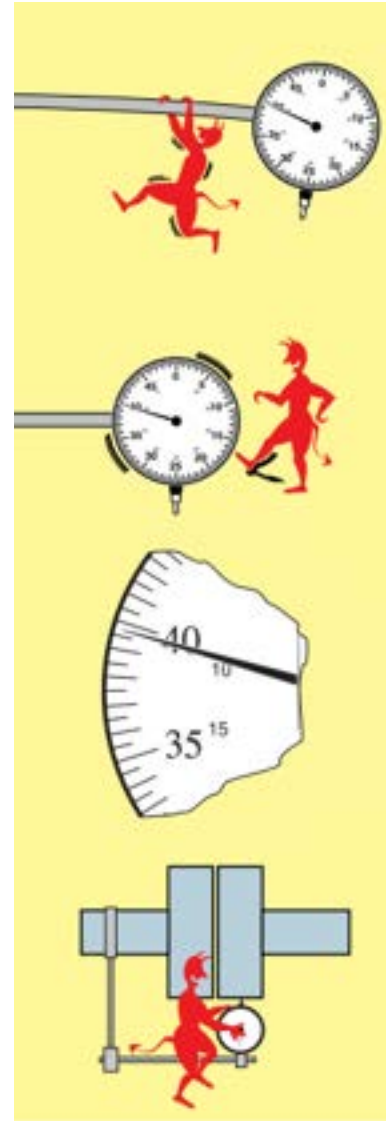



## Short history: Alignment of machines → 1984 PRUFTECHNIK OPTALIGN

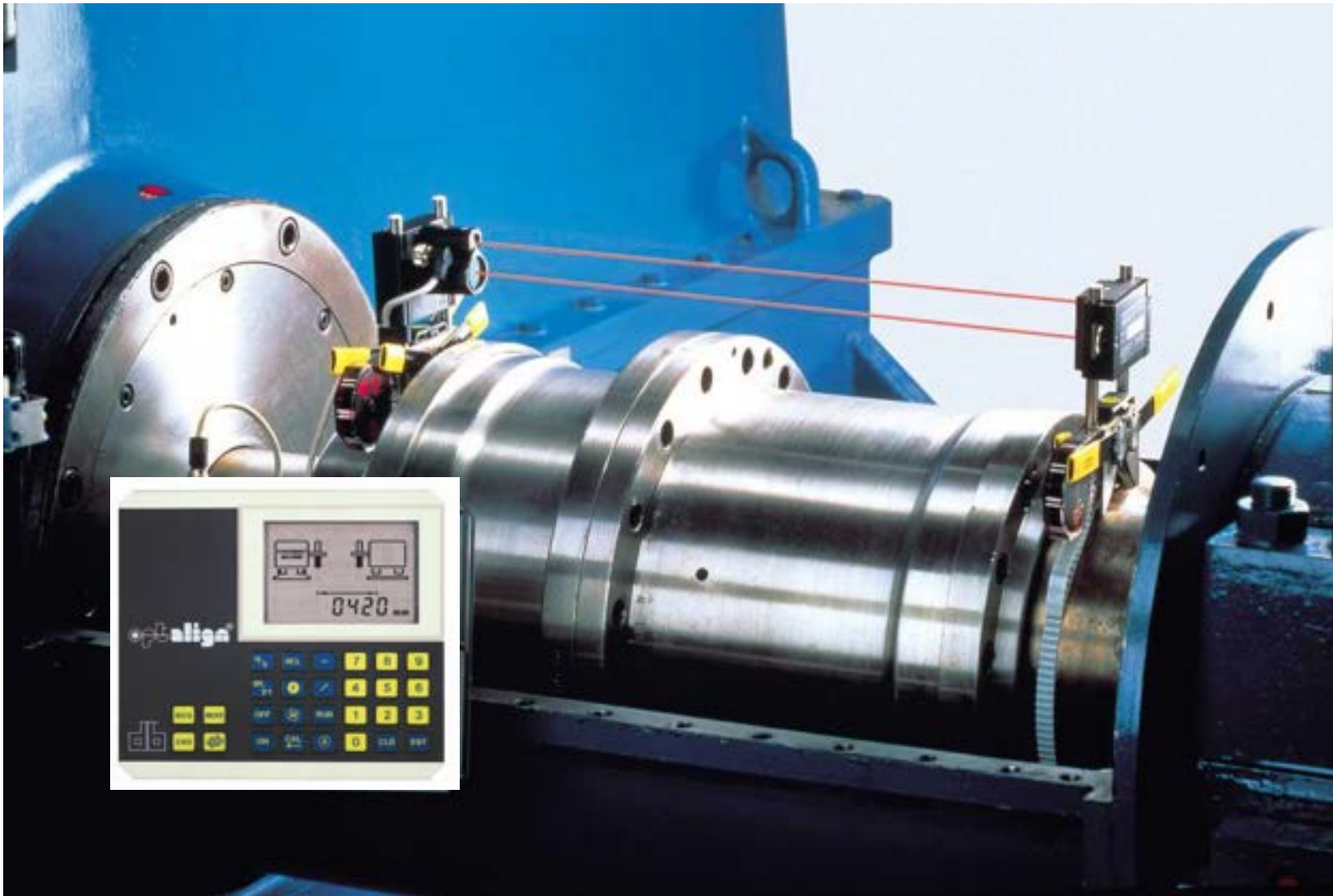

# Short history: Shaft alignment methods

## STRAIGHT EDGE

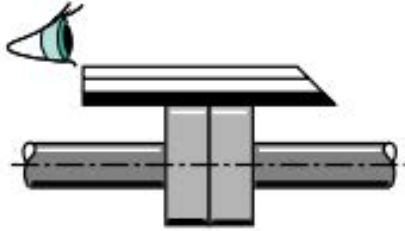

Measurement  
Messen

5 mils  
 $\frac{1}{10}$  mm

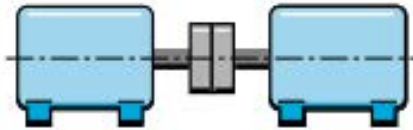

Correction  
Korrigieren

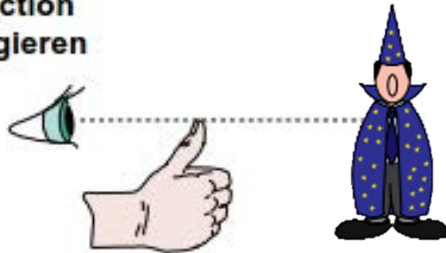

## THE WIZARD

# What is Adaptive Alignment?

**Adaptive Alignment** is the next generation of laser alignment – brought to you by the inventors of laser shaft alignment who continue to innovate in the field.

It is a combination of software and hardware innovations, enabling maintenance teams to address every alignment challenge from simple to complex ... challenges that basic systems cannot handle. Adaptive Alignment systems can adjust:

- To the **asset** itself
- To the alignment **situation** or challenge
- To the **technician** and team charged with completing the alignment task

Adaptive Alignment systems eliminate “guesstimates,” wasted effort, and time-consuming rework that happen with basic laser alignment systems.

Work is completed faster and with higher precision because advanced technology automatically “adapts” in real time, eliminating errors and correcting for situational challenges that other systems cannot.

# Innovations that make Adaptive Alignment possible

## 1. Single Laser Technology

- sensALIGN

## 2. Active Situational Intelligence features, such as:

- Simultaneous Live Move
- Continuous Sweep
- Uncoupled Shaft Awareness
- Freeze-Frame Measurement
- Automatic Multi-Factored Quality Enhancement
- Total Thermal Coverage
- ARC 4.0



## Standard version



## Full featured version

- +  Alignment Reliability Center 4.0
- +  Mobile Connectivity (RFID, Wi-Fi)
- +  Camera

# ROTALIGN *touch*

What are *touch* series

- *touch* is the only existing cloud-enabled touchscreen laser shaft alignment system with integrated connectivity
- Mobile connectivity is built into the design – Wi-Fi, Bluetooth, RFID/NFC, Camera
- Connected with the powerful PC software ALIGNMENT RELIABILITY CENTER 4.0, ROTALIGN *touch* allows you to measure and track the alignment trends
- With it, alignment becomes an integral part of the asset management





Mobile data exchange via cloud can be used everywhere





# **Adaptive Alignment – Examples**

## Example 1: Coupled M/C – ROTATABLE → Continuous Sweep

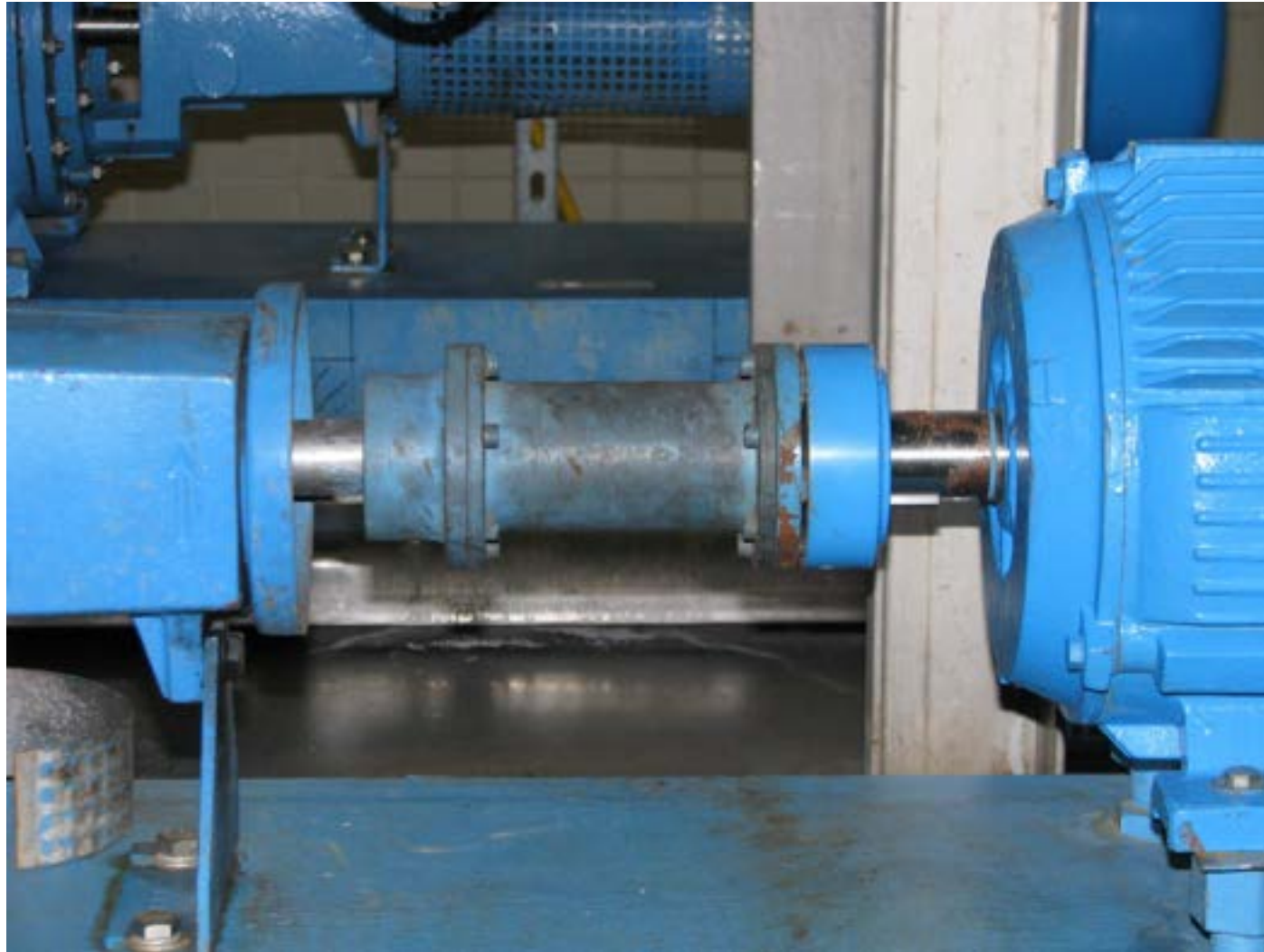

Hans Lenz, PRUFTECHNIK Germany: Pump-Motor coupled application



# Example 1A: Coupled M/C → Continuous Sweep → MEASURE & LIVE MOVE



# Example 1B: Coupled M/C → Continuous Sweep → COUPLING BACKLASH

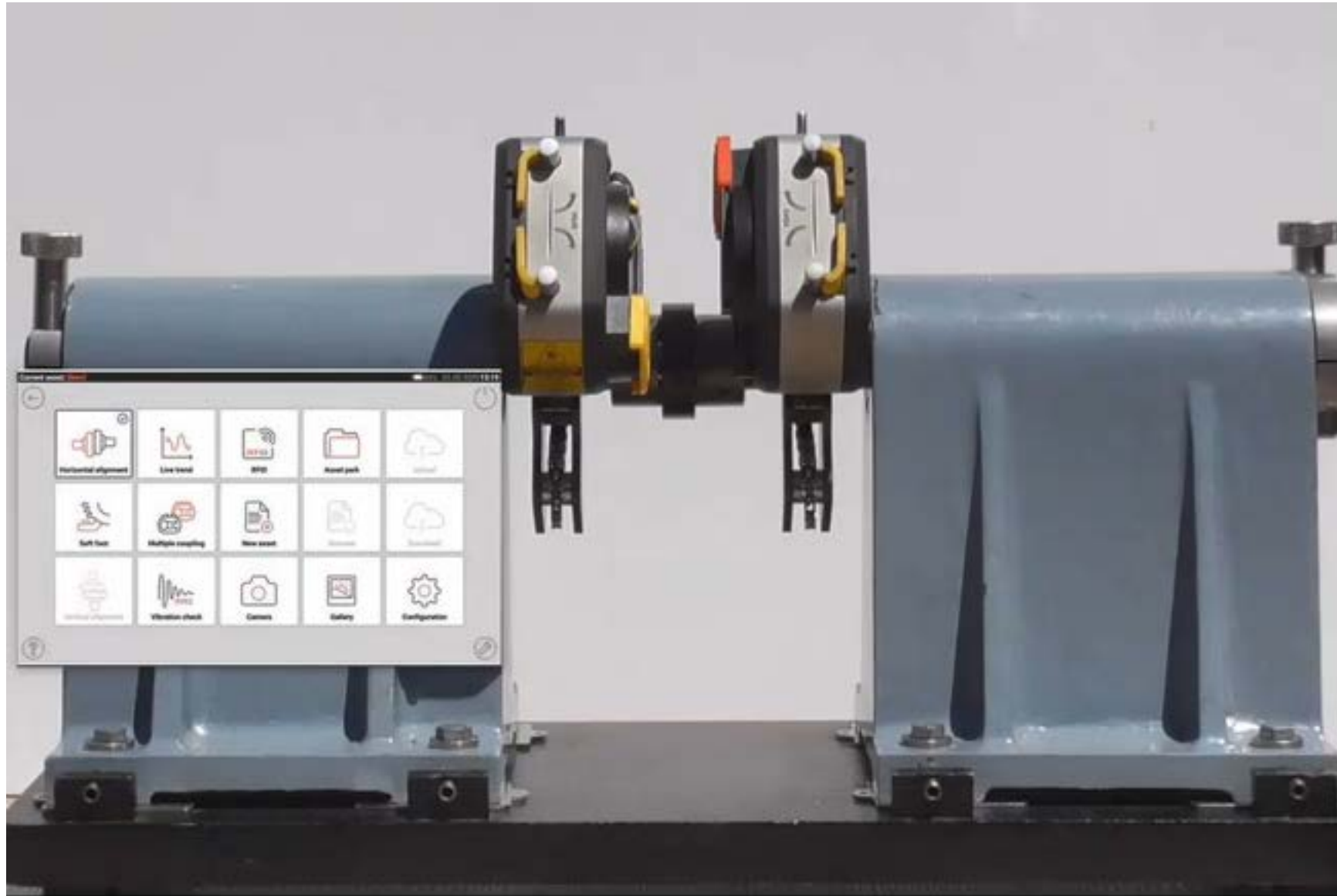

# Example 1C: Coupled M/C → Continuous Sweep → USER ISSUES



## Example 2: Un-Coupled M/C – ROTATABLE → Uncoupled Shaft Awareness

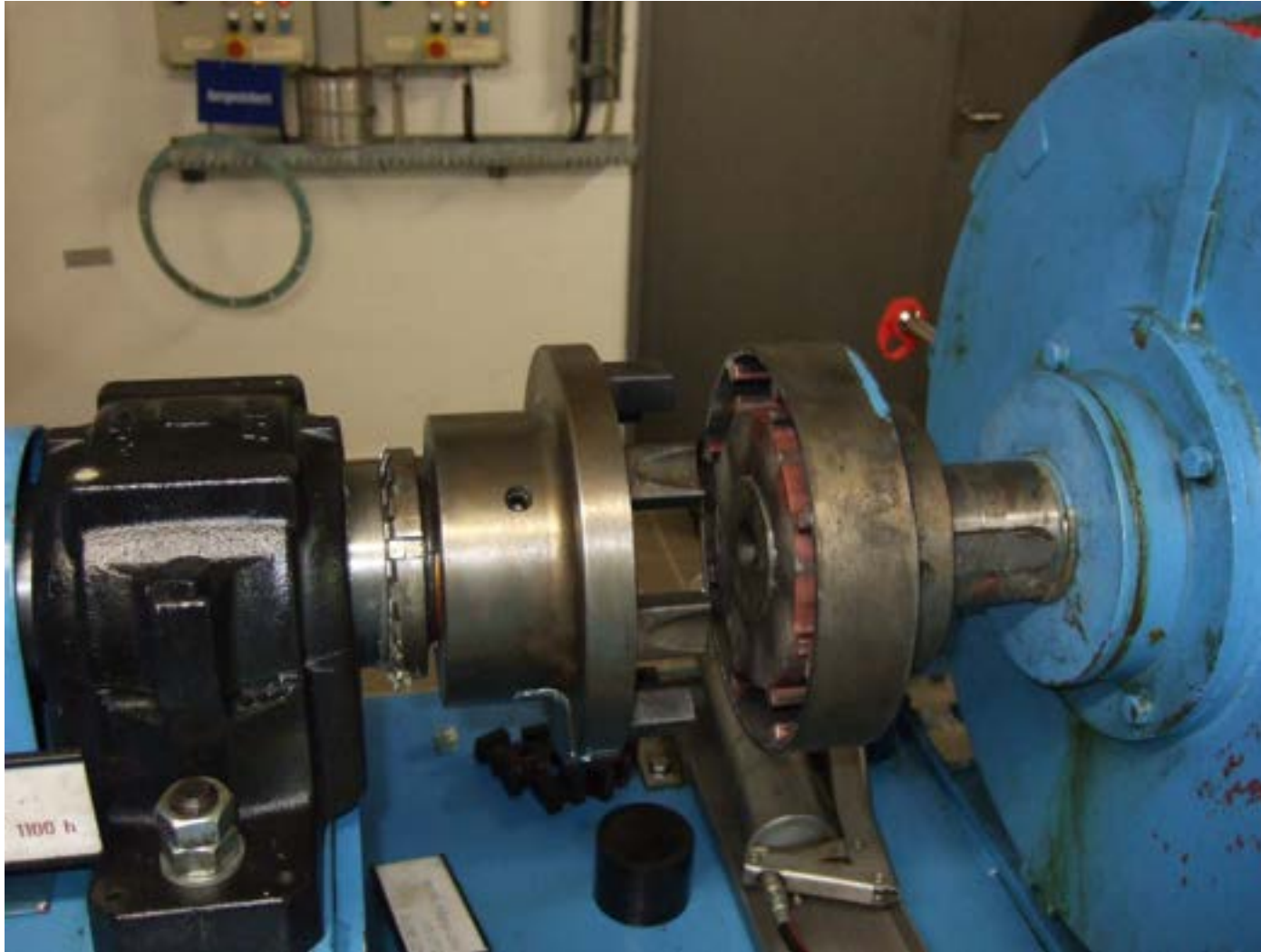

Hans Lenz, PT Germany: Fan-Motor uncoupled application

## Example 2: Un-Coupled M/C – ROTATABLE → Uncoupled Shaft Awareness





## Example 3: Un-Coupled M/C – NON-ROTATABLE → Intelli/Multipoint

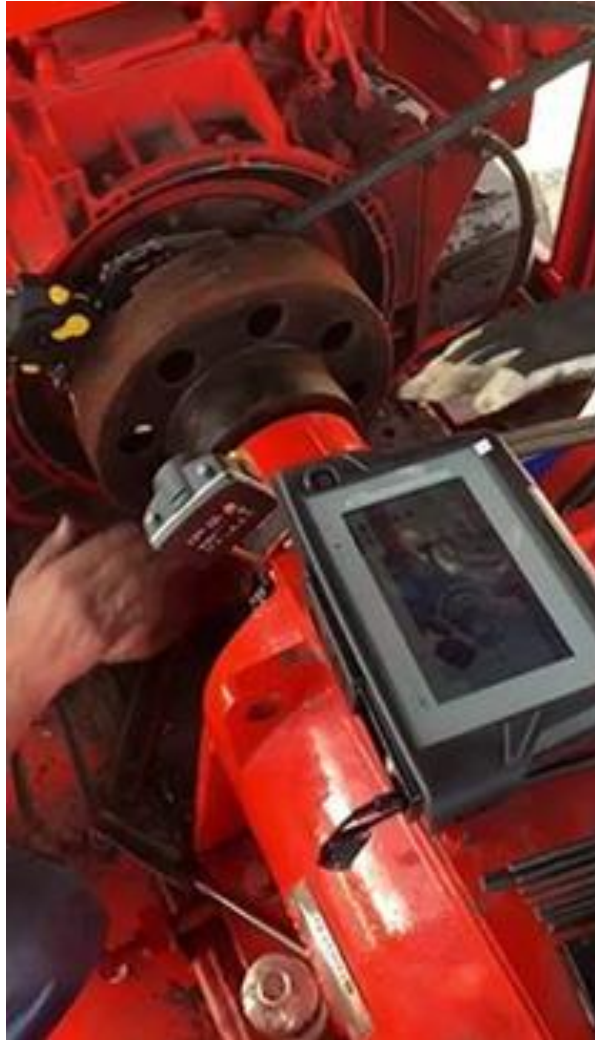

Brandon Zupperdo, Star-tech

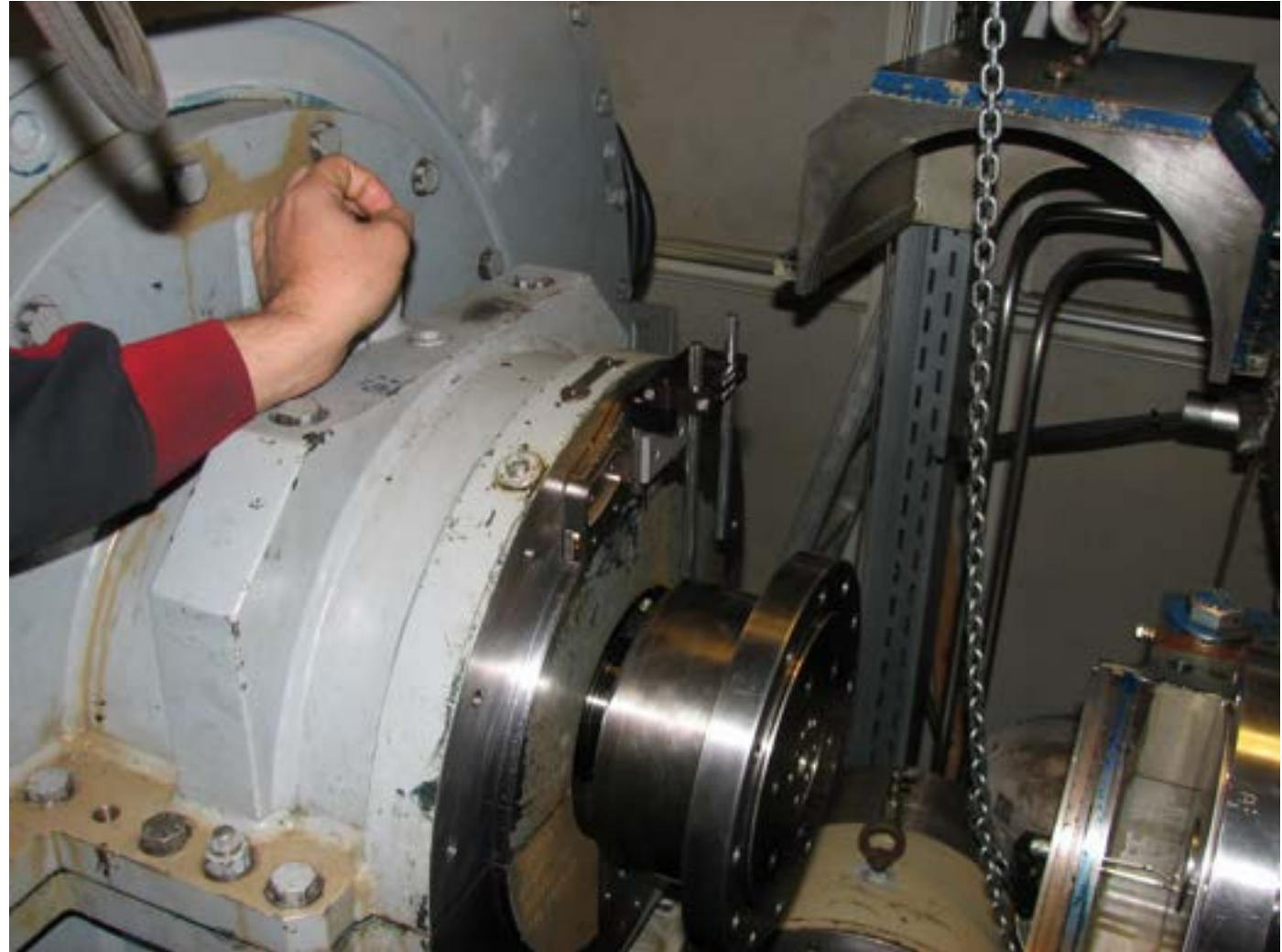

Hans Lenz, PRUFTECHNIK Germany: Planetary gearbox non-rotatable shaft

## Example 3: Un-Coupled M/C – NON-ROTATABLE → Intelli/Multipoint

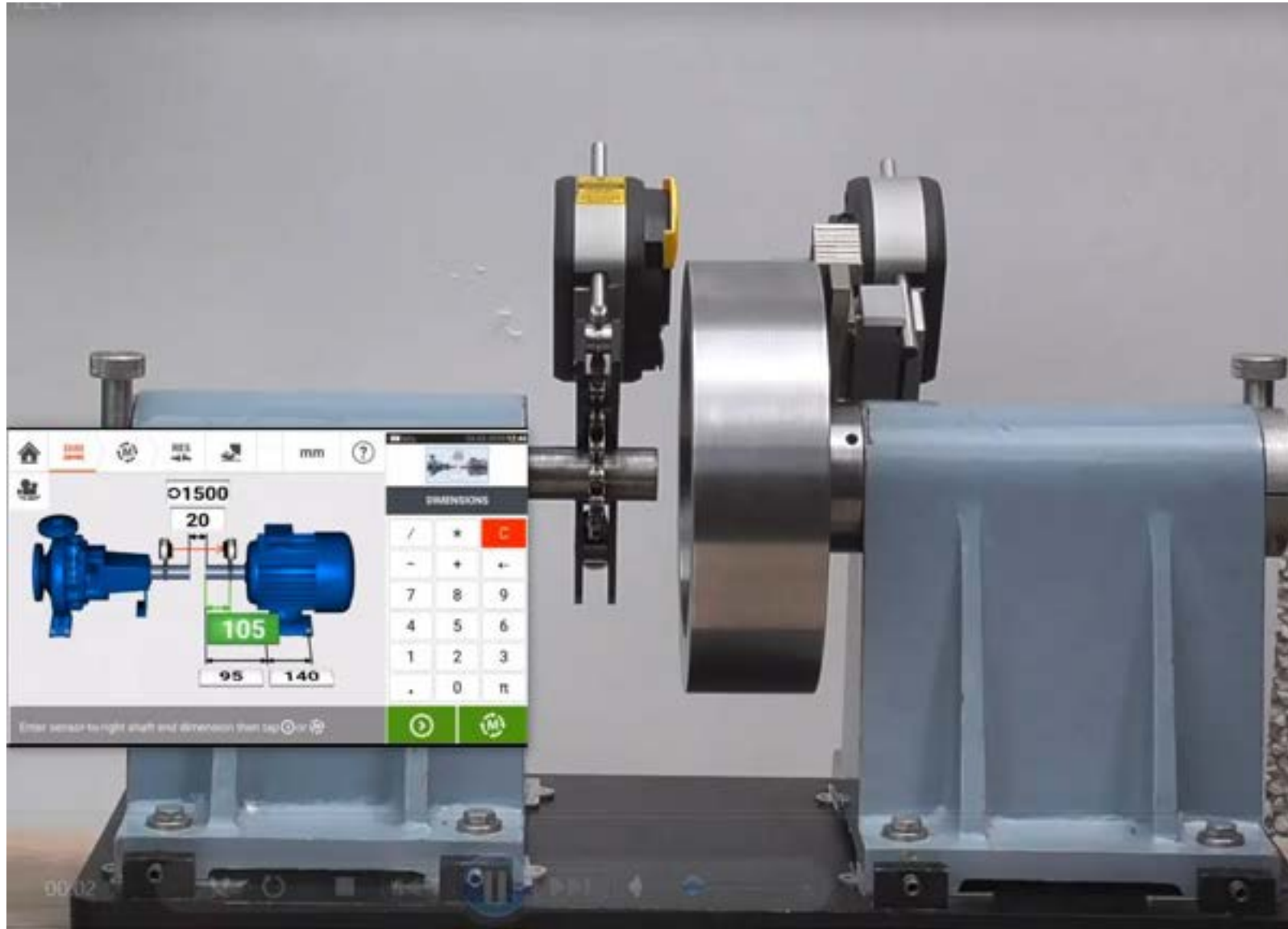

## Example 4: INITIAL MISALIGNMENT → Freeze-Frame Measurement

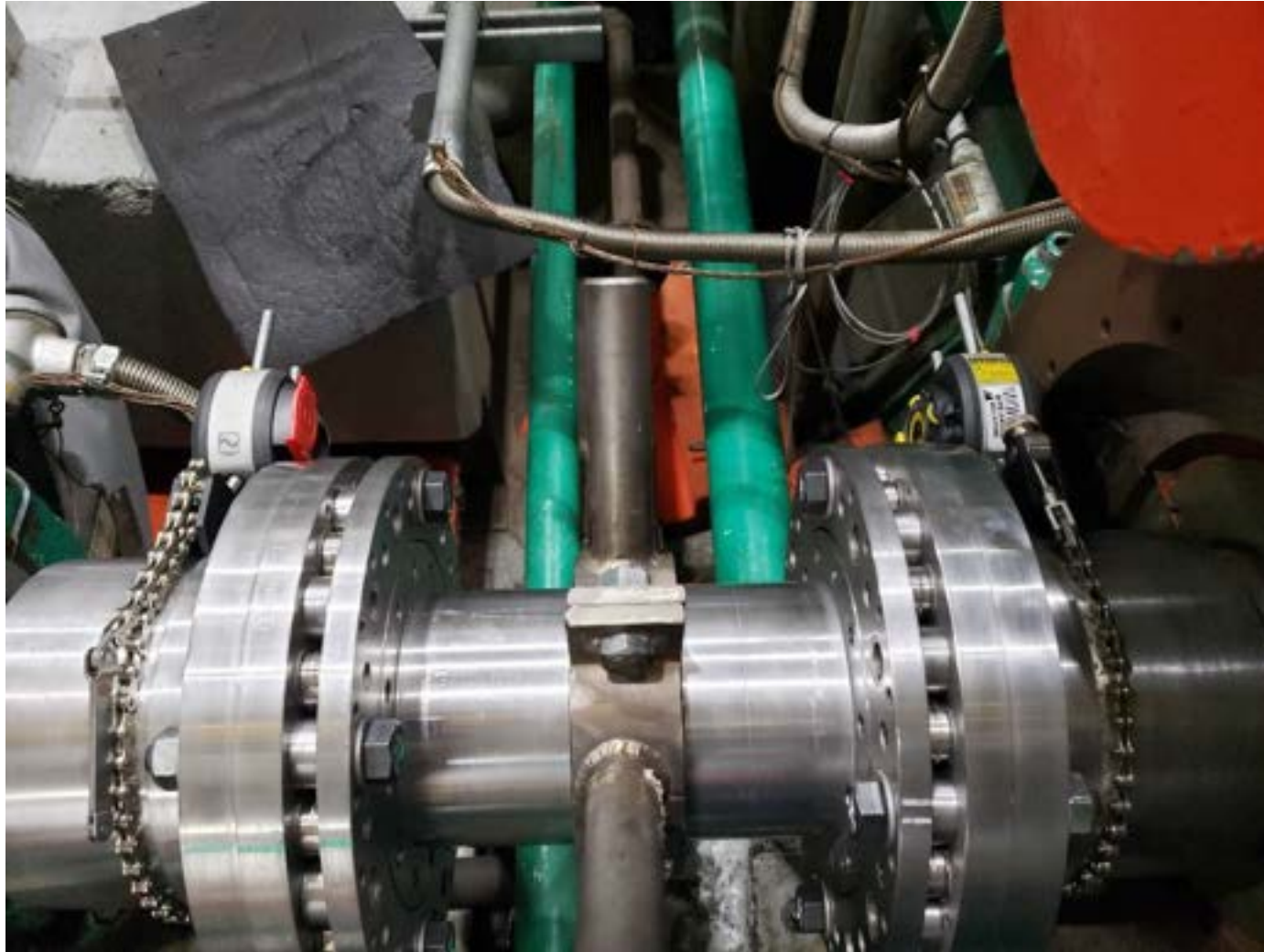

Deron Jozokos, Shoreline Reliability: Turbine driven nuclear feed water pump



## Example 4: INITIAL MISALIGNMENT → Freeze-Frame Measurement



# Examples 1 - 4: Adaptive Alignment measurement summary

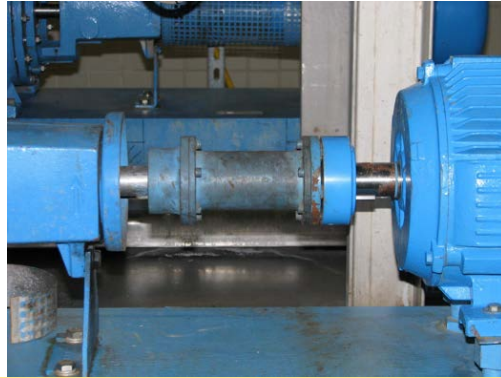

**Asset Situation**

**COUPLED  
ROTATABLE**



## Example 5: MULTI-COUPLING → Simultaneous Machine Train Alignment

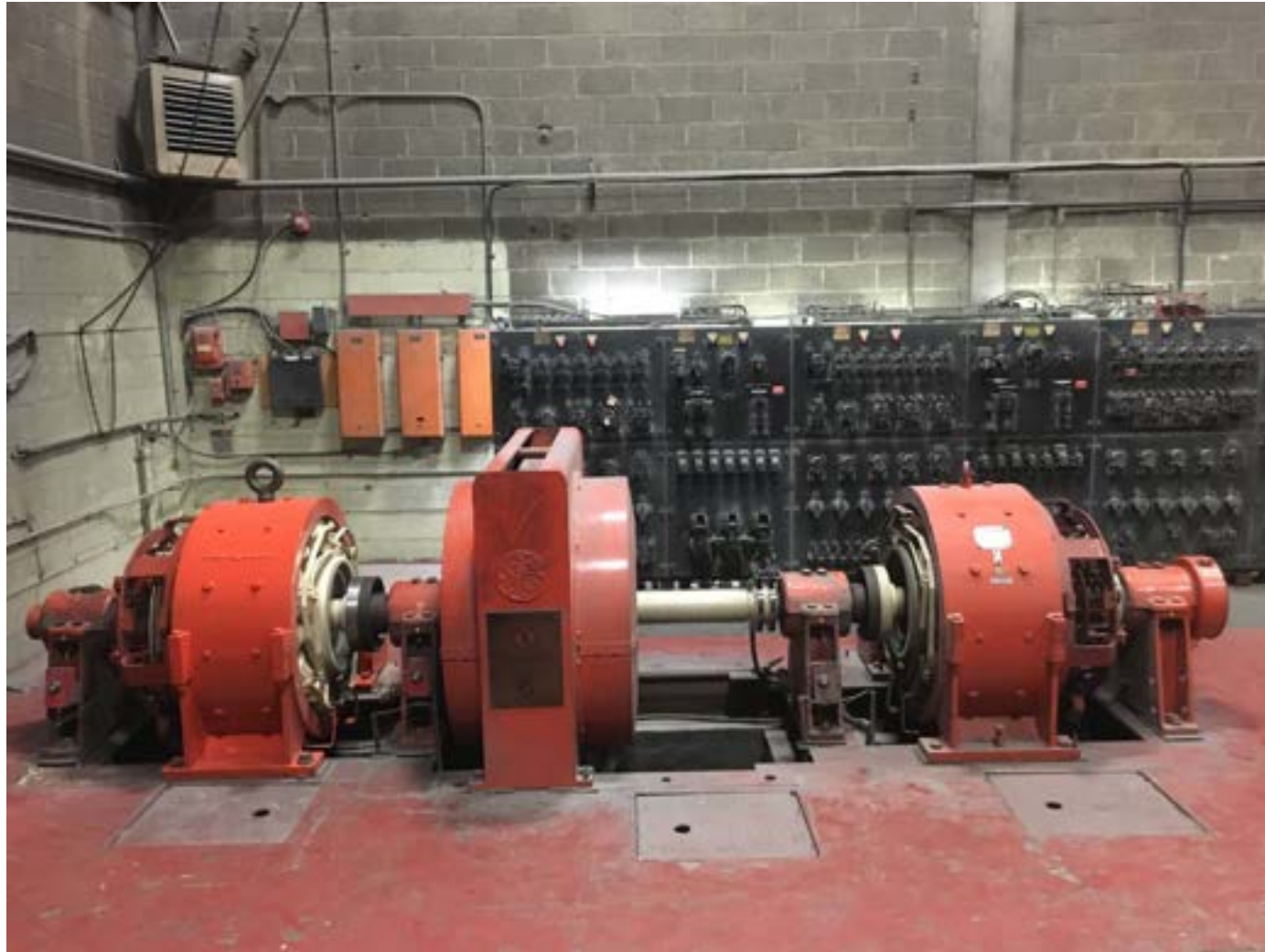

Benoît Marcotte, PRUFTECHNIK Canada: DC Generator machine train

## Example 5: MULTI-COUPLING → Simultaneous Machine Train Alignment

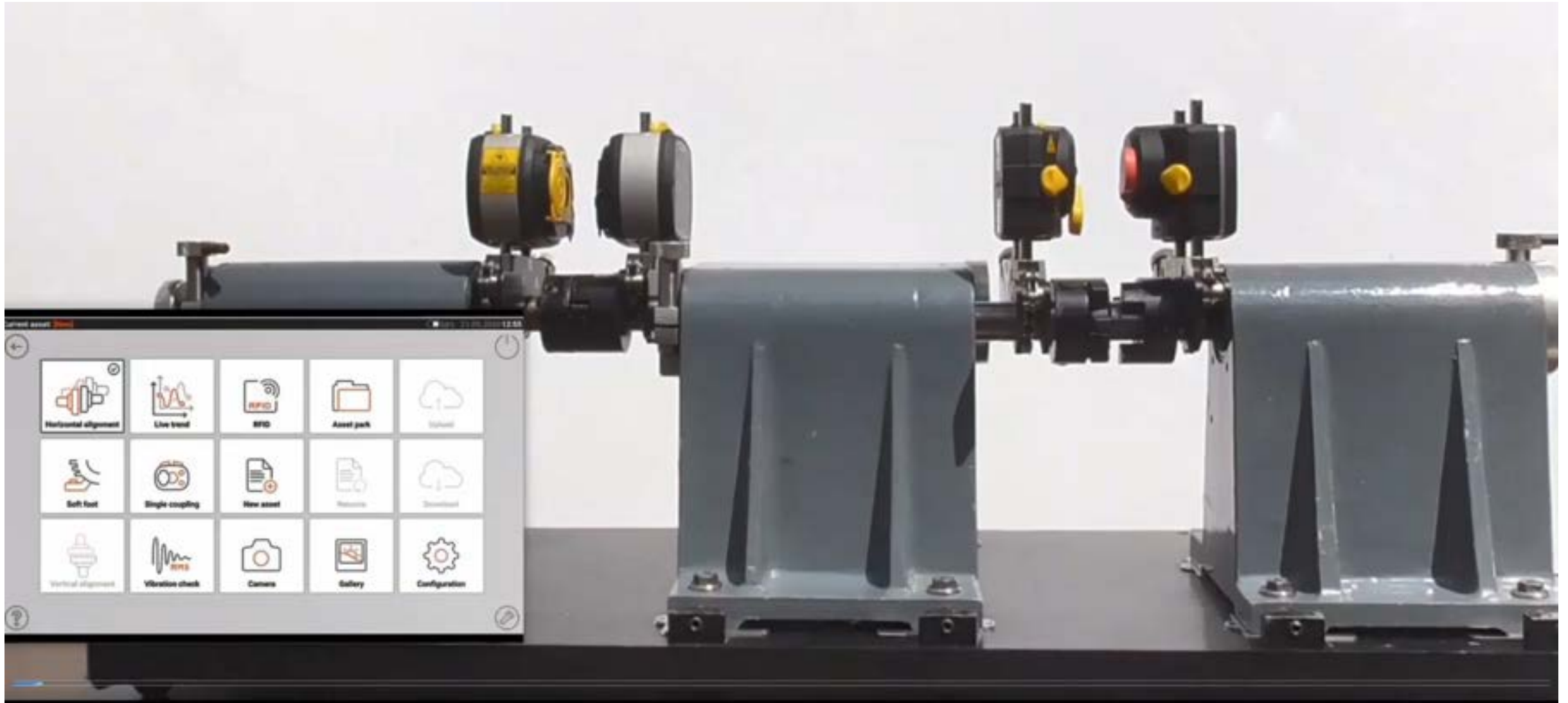

## Example 6: MULTI-COUPLING → Total Thermal Coverage



Benoît Marcotte: Gantry crane



## Example 6: MULTI-COUPLING → Total Thermal Coverage

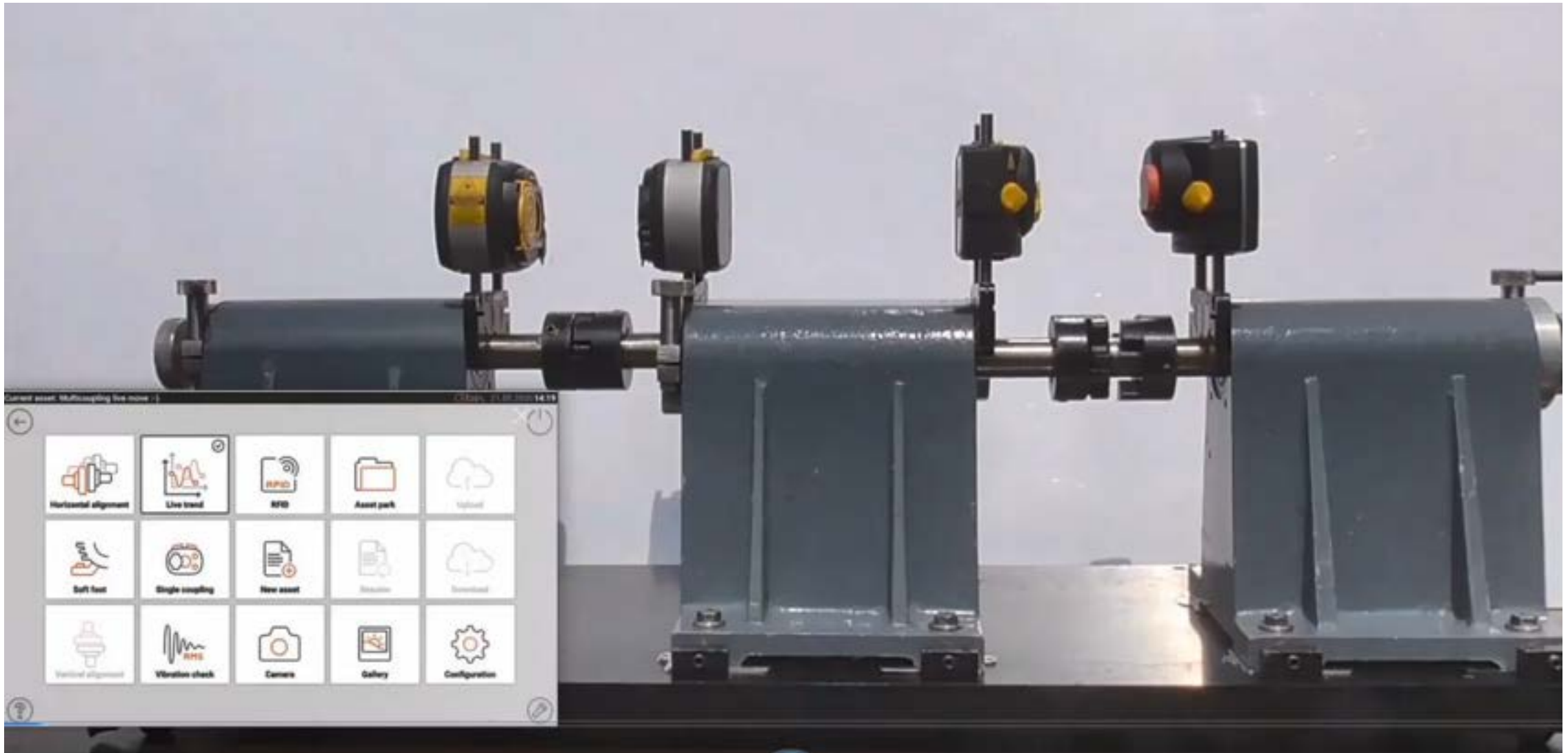

## Example 5 - 6: MULTI-COUPLING → Adaptive Alignment summary

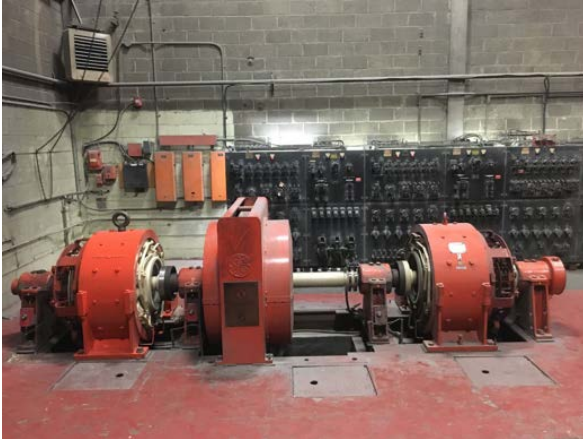

### Multi-Coupling Simultaneous Machine Train Alignment:

- **Asset:** Horizontal Coupled & Uncoupled Shaft Alignment – complete machine-train
- **Active Situational Intelligence:** Monitor measurement and movement on all machines in real-time with automatic detection & elimination of erroneous data
- **User:** Track simultaneously complete machine movement changes to avoid machine-train bolt and base-bound situations with user guidance
- **BENEFITS:** Speed and accuracy of complete machine-train measurements and movements

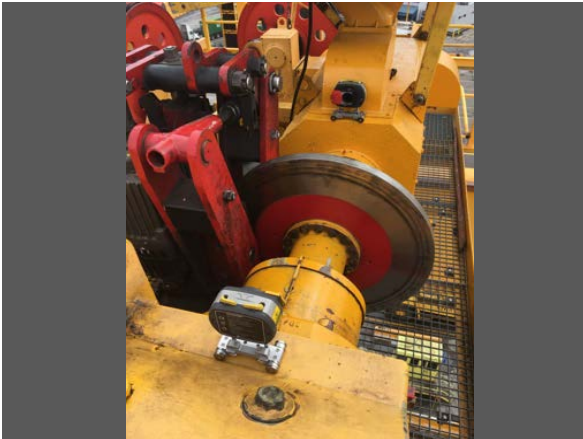

### Multi-Coupling Total Thermal Coverage:

- **Asset:** Horizontal Machine Alignment – complete machine train
- **Active Situational Intelligence:** Measure/Log simultaneously the complete movement of complete machine train
- **User:** Automatic recording of machine-train changes to determine machine pre-sets at coupling and machine feet
- **BENEFITS:** Speed, Simultaneously measure the complete machine train static/dynamic changes



# Value proposition summary – Adaptive Alignment

- **A comprehensive solution that acclimatizes in real time.** Adaptive Alignment achieves results through two major innovations - single laser technology and active situational intelligence. Together, these innovations optimize every alignment task – from simple to complex – minimizing downtime, extending asset life, and enabling technicians to accomplish more every day.
- **Supports a broad range of critical rotating asset types & alignment challenges.** Adaptive alignment quickly and easily handles straightforward alignment jobs, but more importantly it's speed and ease of use expand to support more complex assets and situations, such as machine trains, cardan shafts, long distance measurements, severe misalignments, high-precision tolerances, and more.
- **Every technician can align like a pro.** Adaptive Alignment systems unlock team capacity via real-time situational intelligence and built-in analytics. The system auto-corrects common user errors, enabling less experienced team members to obtain the same high-quality results as more experienced technicians. Unique collaboration facilities enable expert review of measurements, consulting, and mentoring as an alignment job progresses.

# The Extended Warranty program by Fluke Reliability

- The Fluke Reliability Extended Warranty Program offers peace of mind, convenience, device accuracy, and savings on service costs via:
- Extending the manufacturer's warranty from 2 to 5 years
- Three free calibrations:
  - Calibrations for extended warranty customers are prioritized!
  - No risk of calibration price increase (the price of the three calibrations are locked in with purchase of the extended warranty)
- A 15% discount on equipment repairs (not covered by the manufacturer's warranty)



## Convenience and continuity

Calibrations included in Extended Warranty Program will be prioritized. Enables customers to avoid delays in the administrative process.



## Extend protection of customer's investment

Helps customers protect their investment in hardware equipment and maximize ROI. Extended warranty offers customers 5 years of protection.



## Tangible cost savings

Enables customers to secure the cost of asset calibration against rising inflation (price protection). It also includes a 15% discount on repairs not covered by the limited warranty.



## Ensure equipment compliance & maximize equipment uptime

Enables customers to have peace of mind that their equipment is properly calibrated within the right time increments, ensuring the continuity of their device's precision and accuracy. Ensures device operates within designed limits.

## Maintaining your system

- We recommend the parts to be kept in the case if not in use. The system is protected inside the case from impacts, dust and fluids.
- The laser and sensor lens shall be cleaned very careful with the cleaning cloth supplied within the package. This avoids unnecessary scratches.
- Please follow very careful all the recommendations and instructions supplied in the operating manual. The operating manual adds more detailed information.
- The system shall be operated only by trained personal.



# The Prüftechnik Calibration Services



## Calibration by expert technicians:

Highly skilled OEM trained calibration engineers at authorized service partners provide unparalleled product experience and skill in restoring your tools to their full functionality.



## System Inspection & Cleaning

We'll make sure every component is in optimal working condition, safeguarding the reliability of your equipment.



## Preventive Repair:

Our technicians perform essential maintenance, ensuring consistent system functionality and minimizing the risk of future issues.



## Firmware Updates:

When applicable, we'll upgrade your system to the latest firmware, unlocking new capabilities to boost accuracy and efficiency.

## It's a risk you cannot afford.

Neglecting a calibration check for your tool can lead to product defects, costly recalls, regulatory penalties, and unexpected downtime.

## Trust Prüftechnik to maintain the accuracy and reliability you depend on.

Our expert service team will keep your tools precise, resulting in more uptime, reliability, and better product quality.

## Why Calibrate?

Regular tool use in harsh industrial environments can wear out internal components and damage optical surfaces, putting it at risk of lower accuracy. This can result in product recalls, unexpected downtime, and loss of ROI.

## Regular calibration checks are your best defence.

A calibration service every 2 years will give you peace of mind that your tools are in tolerance of Prüftechnik systems, enabling uptime, reliability, and product quality.

# Academic Training Courses

**MOBIUS Institute - Precision Shaft Alignment**

**MOBIUS Institute - Certified Vibration Analysis ISO 18436-2, Cat. I**

**MOBIUS Institute - Certified Vibration Analysis ISO 18436-2, Cat. II**

**MOBIUS Institute - Certified Vibration Analysis ISO 18436-2, Cat. III**

**MOBIUS Institute - Asset Reliability Practitioner (ONLINE)**

**FLUKE Vibration Analysis (CM) Level I**

**FLUKE Vibration Analysis (CM) Level II**

**FLUKE Field Balancing**





# QUESTIONS?



Thank you!

**Keith Chuah**

[frs.sales@fluke.com](mailto:frs.sales@fluke.com)

<https://www.pruftechnik.com/en-SG/>

## To learn more about **Fluke Reliability** and our **Webinar Series**



### **SURVEY**

Please provide feedback on this webinar by responding to our survey. Do you want a Certificate of Attendance?



### **WEBINAR SERIES**

Visit this page to learn more about our Webinar Series:  
<https://www.accelix.com/community/best-practice-webinars/>



### **DEMO**

Visit [Accelix.com](https://www.accelix.com) for a free demo of our Connected Reliability Framework.



**FLUKE®**

Reliability

**THANK YOU!**